

For Office Use Only

SURVEYS OF CONSUMERS



The University of Michigan
Survey Research Center
Institute for Social Research

MAY 2007

1. Coversheet ID #'s:

2				
---	--	--	--	--

REINTERVIEW
NOVEMBER 2006

--	--	--	--	--

RDD ID NUMBER

2.

--	--	--

 RESPONDENT'S
AREA CODE

3. Interviewer's ID No. _____

4. Date IW Began _____

5. Date IW Completed _____

6. Length of IW _____ (Minutes)

7. Length of Edit _____ (Minutes)

8. Supervisor's ID No. _____

9. Coders' ID No. _____

10. INTERVIEWER CHECKPOINT:

<u>COMPLETE:</u>	
<input type="checkbox"/>	1. IW COMPLETED WITH <u>NO</u> INTERRUPTION REQUIRING CALLBACK
<input type="checkbox"/>	2. IW COMPLETED WITH ONE OR MORE INTERRUPTIONS REQUIRING CALLBACK
<u>PARTIAL:</u>	
<input type="checkbox"/>	3. BREAKOFF BEFORE SECTION E
<input type="checkbox"/>	4. BREAKOFF DURING SECTION E
<input type="checkbox"/>	5. BREAKOFF AFTER SECTION E

11. INTERVIEWER CHECKPOINT:

<input type="checkbox"/>	1. COVERSHEET IS RDD
<input type="checkbox"/>	2. COVERSHEET IS RECONTACT

12. INTERVIEWER CHECKPOINT:

INTERVIEW LANGUAGE:	
<input type="checkbox"/> 1. ENGLISH	<input type="checkbox"/> 2. SPANISH

THE FOLLOWING STATEMENT MUST BE READ TO ALL RESPONDENTS:

Before we begin, I would like to assure you that the interview is confidential and completely voluntary. If we should come to any question that you don't want to answer, just let me know and we'll go on to the next question. The survey contains questions regarding your perspectives on the economy, financial investments, societies, feelings, and Internet usage. The questionnaire will take approximately thirty minutes to complete.

T1. Did R provide any information not already recorded in the interview or in a marginal note about changes which may have occurred to R or family members during the past year in any of the following:

a. job status? NO YES -> SPECIFY: _____

b. health? NO YES -> SPECIFY: _____

c. living arrangements? NO YES -> SPECIFY: _____

d. finances? NO YES -> SPECIFY: _____

f. other changes? NO YES -> SPECIFY: _____

T2. Please describe any ambiguous or conflicting situation that you want coding to know about:

NONE _____

T3. Were there any serious problems with the interview, such as R's difficulty in hearing or understanding the questions, etc., which affected the quality of the interview?

NONE _____

SECTION A

A2. We are interested in how people are getting along financially these days. Would you say that you (and your family living there) are better off or worse off financially than you were a year ago?

- 1. BETTER NOW
- 3. SAME
- 5. WORSE
- 8. DON'T KNOW

A2a. Why do you say so? (Are there any other reasons?) _____

A3. Now looking ahead--do you think that a year from now you (and your family living there) will be better off financially, or worse off, or just about the same as now?

- 1. WILL BE
BETTER OFF
- 3. SAME
- 5. WILL BE
WORSE OFF
- 8. DON'T KNOW

A4. Now turning to business conditions in the country as a whole--do you think that during the next 12 months we'll have good times financially, or bad times, or what?

- 1. GOOD TIMES
- 2. GOOD WITH QUALIFICATIONS
- 3. PRO-CON
- 4. BAD WITH QUALIFICATIONS
- 5. BAD TIMES
- 8. DON'T KNOW

A5. Would you say that at the present time business conditions are better or worse than they were a year ago?

- 1. BETTER NOW
- 3. ABOUT THE SAME
- 5. WORSE NOW

A6. During the last few months, have you heard of any favorable or unfavorable changes in business conditions?

YES



NO; HAVEN'T HEARD

GO TO A7

A6a. What did you hear? (Have you heard of any other favorable or unfavorable changes in business conditions?)

IF NOT CLEAR WHETHER A CHANGE IS FAVORABLE OR UNFAVORABLE, PROBE: "Would (MENTION CHANGE) be favorable or unfavorable?" AND NOTE "FAVORABLE" OR "UNFAVORABLE."

A7. And how about a year from now, do you expect that in the country as a whole business conditions will be better, or worse than they are at present, or just about the same?

1. BETTER A YEAR FROM NOW

3. ABOUT THE SAME

5. WORSE A YEAR FROM NOW

- A8. Looking ahead, which would you say is more likely--that in the country as a whole we'll have continuous good times during the next 5 years or so, or that we will have periods of widespread unemployment or depression, or what?

IF R ANSWERS IN COMPARATIVE TERMS, I.E., "BETTER," "WORSE," OR "SAME," PROBE: "Would that be good times or bad times?"

- A9. As to the economic policy of the government--I mean steps taken to fight inflation or unemployment--would you say the government is doing a good job, only fair, or a poor job?

1. GOOD JOB

3. ONLY FAIR

5. POOR JOB

8. DON'T KNOW

- A10. How about people out of work during the coming 12 months--do you think that there will be more unemployment than now, about the same, or less?

1. MORE UNEMPLOYMENT

3. ABOUT THE SAME

5. LESS UNEMPLOYMENT

- A11. No one can say for sure, but what do you think will happen to interest rates for borrowing money during the next 12 months--will they go up, stay the same, or go down?

1. GO UP

3. STAY THE SAME

5. GO DOWN

8. DON'T KNOW

A12. During the next 12 months, do you think that prices in general will go up, or go down, or stay where they are now?

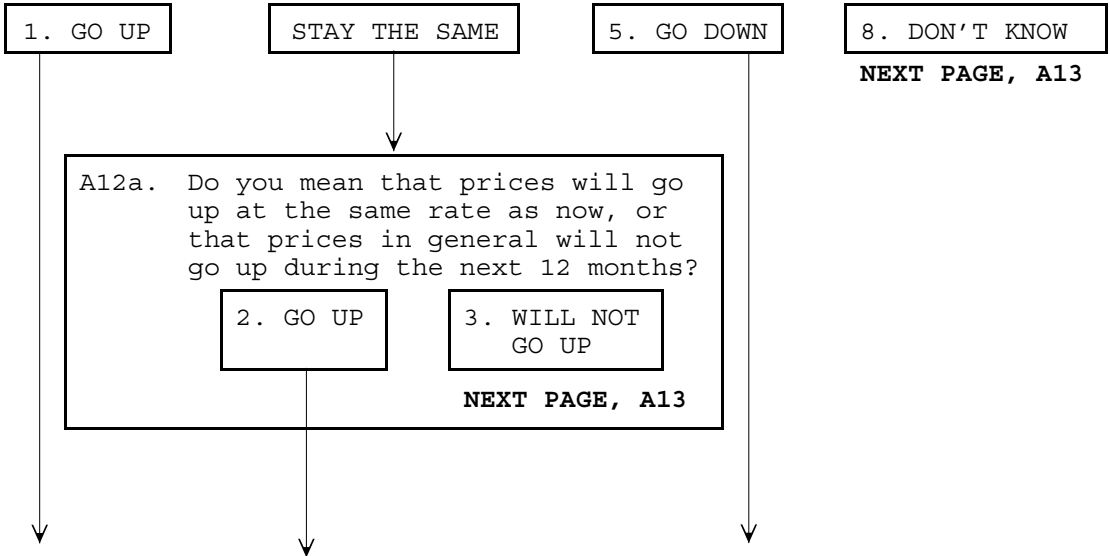

A12b. By about what percent do you expect prices to go (up/down) on the average, during the next 12 months? (USE PROBE BELOW IF ANSWER IS GREATER THAN 5%)

_____ PERCENT

NEXT PAGE, A13

DON'T KNOW

↓

A12c. (AFTER A DON'T KNOW RESPONSE IS PROBES, IF R SAYS, "I DON'T KNOW", USE THE FOLLOWING PROBE:) (USE PROBE BELOW IF ANSWER IS GREATER THAN 5%)

How many cents on the dollar do you expect prices to go (up/down) on the average, during the next 12 months?

_____ CENTS ON DOLLAR

98. DON'T KNOW

IF R GIVES AN ANSWER THAT IS GREATER THAN 5%, PLEASE PROBE WITH:

"Let me make sure I have that correct. You said that you expect prices to go (up/down) during the next 12 months by (X) percent. Is that correct?"

A13. What about the outlook for prices over the next 5 to 10 years? Do you think prices will be higher, about the same, or lower, 5 to 10 years from now?

1. HIGHER	STAY THE SAME	5. LOWER	8. DON'T KNOW		
↓	↓	↓	↓		
<div style="border: 1px solid black; padding: 10px; margin: 0 auto; width: 80%;"> <p>A13a. Do you mean that prices will go up at the same rate as now, or that prices in general will not go up during the next 5 to 10 years?</p> <table style="width: 100%; border: none;"> <tr> <td style="width: 50%; text-align: center; border: 1px solid black; padding: 5px;">2. GO UP</td> <td style="width: 50%; text-align: center; border: 1px solid black; padding: 5px;">3. WILL NOT GO UP</td> </tr> </table> <p style="text-align: center; margin-top: 5px;">NEXT PAGE, A14</p> </div>				2. GO UP	3. WILL NOT GO UP
2. GO UP	3. WILL NOT GO UP				
↓	↓	↓			

NEXT PAGE, A14

NEXT PAGE, A14

A13b. By about what percent per year do you expect prices to go (up/down) on the average, during the next 5 to 10 years? (USE PROBE BELOW IF ANSWER IS GREATER THAN 5%)

_____ PERCENT

NEXT PAGE, A14

DON'T KNOW

↓

A13c. (AFTER A DON'T KNOW RESPONSE IS PROBED, IF R SAYS, "I DON'T KNOW", USE THE FOLLOWING PROBE:) (USE PROBE BELOW IF ANSWER IS GREATER THAN 5%)

How many cents on the dollar per year do you expect prices to go (up/down) on the average, during the next 5 to 10 years?

_____ CENTS ON DOLLAR

98. DON'T KNOW

IF R GIVES AN ANSWER THAT IS GREATER THAN 5%, PLEASE PROBE WITH:

"Would that be (X) percent per year, or is that the total for the next 5 to 10 years?"

IF R HAS GIVEN A TOTAL FOR THE NEXT FIVE TO TEN YEARS, ASK:
"About what percent per year would that be?"

6

A14. During the next year or two, do you expect that your (family) income will go up more than prices will go up, about the same, or less than prices will go up?

1. INCOME UP MORE
THAN PRICES

3. INCOME UP SAME
AS PRICES

5. INCOME UP LESS
THAN PRICES

8. DON'T
KNOW

A15. During the next 12 months, do you expect your (family) income to be higher or lower than during the past year?

1. HIGHER

3. ABOUT THE SAME
GO TO A16

5. LOWER

8. DON'T KNOW
GO TO A16



A15a. By about what percent do you expect your (family) income to (increase/decrease) during the next 12 months?

_____ PERCENT

98. DON'T KNOW

A16. Generally speaking, do you think now is a good time or a bad time to buy a house?

1. GOOD

3. PRO-CON

5. BAD

8. DON'T KNOW
NEXT PAGE, A17



A16a. Why do you say so? (Are there any other reasons?) _____

A17. What about selling a house -- generally speaking, do you think now is a good time or a bad time to sell a house?



A17a. Why do you say so? (Are there any other reasons?) _____

A18. About the big things people buy for their homes--such as furniture, a refrigerator, stove, television, and things like that. Generally speaking, do you think now is a good or a bad time for people to buy major household items?

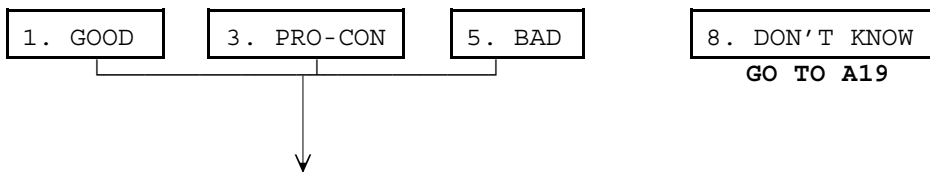

A18a. Why do you say so? (Are there any other reasons?) _____

A19. Speaking now of the automobile market--do you think the next 12 months or so will be a good time or a bad time to buy a vehicle, such as a car, pickup, van or sport utility vehicle?



A19a. Why do you say so? (Are there any other reasons?) _____

A20. Do you think that the price of gasoline will go up during the next five years, will gasoline prices go down, or will they stay about the same as they are now?

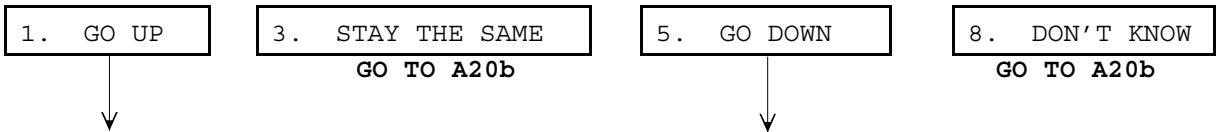

A20a. About how many cents per gallon do you think gasoline prices will (increase/decrease) during the next five years compared to now?

_____ CENTS PER GALLON

998. DON'T KNOW

A20b. Now thinking only about the next twelve months, do you think that the price of gasoline will go up during the next twelve months, will gasoline prices go down, or will they stay about the same as they are now?

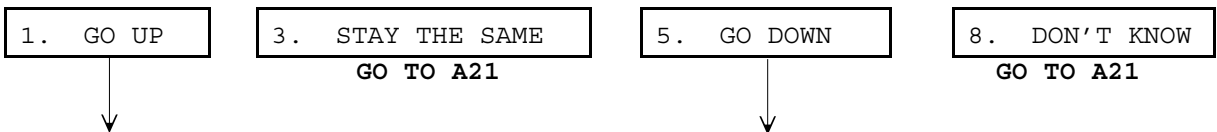

A20c. About how many cents per gallon do you think gasoline prices will (increase/decrease) during the next twelve months compared to now?

_____ CENTS PER GALLON

998. DON'T KNOW

FAMILY INCOME

A21. To get a picture of people's financial situation we need to know the general range of income of all people we interview. Now, thinking about (your/your family's) total income from all sources (including your job), how much did (you/your family) receive in 2006?

GO TO A26

999998. DON'T KNOW

↓
GO TO A22

A22. Did (you/your family) receive \$50,000 or more in 2006?

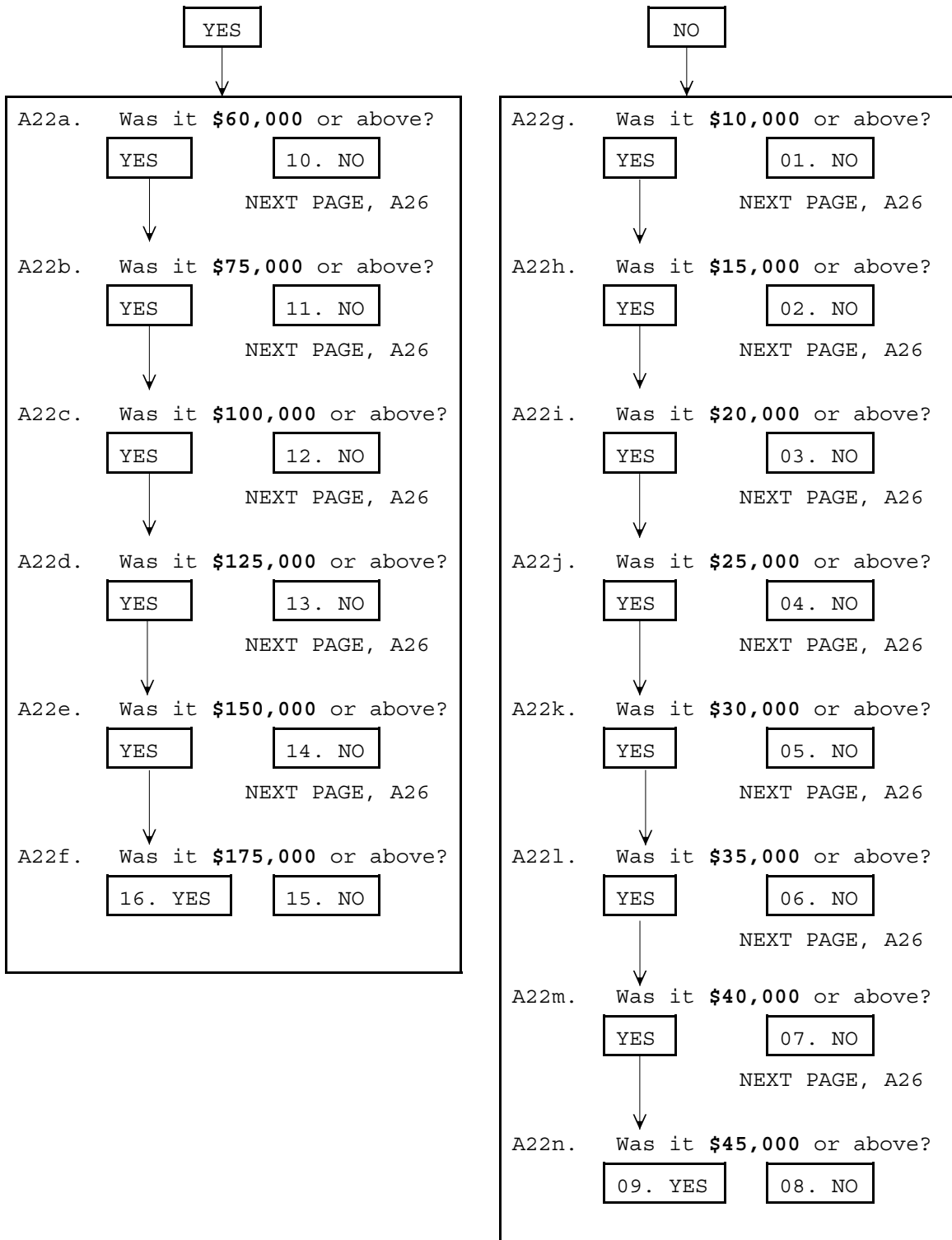

A26. Do you (and your family living there) own your home, pay rent, or what?

1. OWNS OR IS BUYING	2. RENT	7. OTHER (SPECIFY): _____
----------------------	---------	---------------------------

↓

GO TO A27e

A27. Do you think the current value of your home--I mean, what it would bring if you sold it today--has increased compared with a year ago, has decreased compared with a year ago, or has it remained about the same?

1. INCREASED IN VALUE	3. SAME	5. DECREASED IN VALUE
-----------------------	---------	-----------------------

A27a. What is the current market value of your home? (If you sold it today, how much would it bring in?)

\$ _____

9999998. DON'T KNOW

A27b. During the next 12 months, do you plan to refinance your mortgage and borrow more money than you currently owe on the mortgage?

1. YES, REFINANCE AND BORROW MORE	5. NO; NO MORTGAGE
-----------------------------------	--------------------

↓

GO TO A27e

A27c. How much more money do you plan to you borrow, beyond what you now owe on your mortgage?

\$ _____

9999998. DON'T KNOW

A27d. How do you plan to use that money?
[CHECK ALL THAT APPLY]

A. HOME IMPROVEMENTS	B. PAY DOWN/OFF OTHER DEBTS/LOANS	C. BUY A CAR OR OTHER BIG ITEM
D. BUSINESS EXPENSES	E. EDUCATIONAL OR MEDICAL EXPENSES	F. OTHER (SPECIFY): _____

A27e. What do you think will happen to the prices of homes (like yours) in your community over the next 12 months? Will they increase at a rapid rate, increase at a moderate rate, remain about the same, decrease at a moderate rate, or decrease at a rapid rate?

- | | | | | |
|-----------------------------------|---|--------------------------------|---|-----------------------------------|
| 1. INCREASE
AT A RAPID
RATE | 2. INCREASE
AT A
MODERATE
RATE | 3. REMAIN
ABOUT
THE SAME | 4. DECREASE
AT A
MODERATE
RATE | 5. DECREASE
AT A RAPID
RATE |
|-----------------------------------|---|--------------------------------|---|-----------------------------------|

A27f. INTERVIEWER CHECKPOINT:

1. HOMEOWNERS (A26=1) AND HOME PRICES WILL INCREASE OR DECREASE IN NEXT 12 MONTHS (A27c=1,2,4,5) --> **GO TO A27g**

2. HOMEOWNERS (A26=1) AND HOME PRICES WILL REMAIN SAME (A27c=3) --> **GO TO A27h**

3. NON-HOMEOWNERS --> **GO TO A28**

A27g. By about what percent do you expect prices of homes like yours in your community to go (up/down), on average, over the next 12 months?

_____ PERCENT

98. DON'T KNOW

A27h. What about the outlook for prices of homes like yours in your community over the next 5 years or so? Do you expect them to increase, remain about the same, or decrease?

- | | | |
|-------------|-------------------|-------------|
| 1. INCREASE | 3. ABOUT THE SAME | 5. DECREASE |
| ↓ | GO TO A28 | ↓ |

A27i. By about what percent per year do you expect prices of homes like yours in your community to go (up/down), on average, over the next 5 years or so?

_____ PERCENT

98. DON'T KNOW

A28. The next few questions ask about your views of the chances that various events will happen. Your answers can range from zero to one hundred, where zero means there is absolutely no chance, and one hundred means that it is absolutely certain. For example, when weather forecasters report the chance of rain, a number like 20 percent means "a small chance", a number around 50 percent means "a pretty even chance," and a number like 80 percent means "a very good chance."

A28a. What do you think the chances are that your (family) income will increase by more than the rate of inflation during the next five years or so?

_____PERCENT

A28b. During the next 5 years, what do you think the chances are that you (or your husband/wife) will lose a job that you wanted to keep?

_____PERCENT

A28c. What do you think the chances are that [IF R UNDER AGE 65] (when you retire,) your income from Social Security and job pensions will be adequate to maintain your living standards?

_____PERCENT

A28d. Compared with 5 years ago, do you think the chances that you (and your husband/wife) will have a comfortable retirement have gone up, gone down, or remained about the same?

1. GONE UP

3. SAME

5. GONE DOWN

A29. The next question is about investing in the stock market. Please think about the type of mutual fund known as a diversified stock fund. This type of mutual fund holds stock in many different companies engaged in a wide variety of business activities. Suppose that tomorrow someone were to invest one thousand dollars in such a mutual fund. Please think about how much money this investment would be worth one year from now.

What do you think is the percent chance that this one thousand dollar investment will increase in value in the year ahead, so that it is worth more than one thousand dollars one year from now?

_____PERCENT CHANCE

A29a. Next I would like to ask you about your OWN (personal) income prospects in the next twelve months. What do you think is the percent chance that your income in the next twelve months will be higher than your income in the past twelve months?

_____PERCENT CHANCE

BLANK PAGE

SECTION AA: FINANCIAL INVESTMENTS

AA1. The next questions are about investments in the stock market. First, do you (or any member of your family living there) have any investments in the stock market, including any publicly traded stock that is directly owned, stocks in mutual funds, stocks in any of your retirement accounts, including 401(K)s, IRAs, or Keogh accounts?

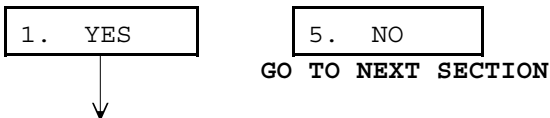

AA2. Considering all of your (family's) investments in the stock market, overall about how much would your investments be worth today? (PROBE: What is your best estimate?)

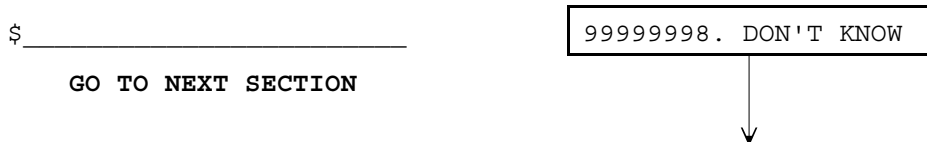

AA2a. Would the total be \$25,000 or more?

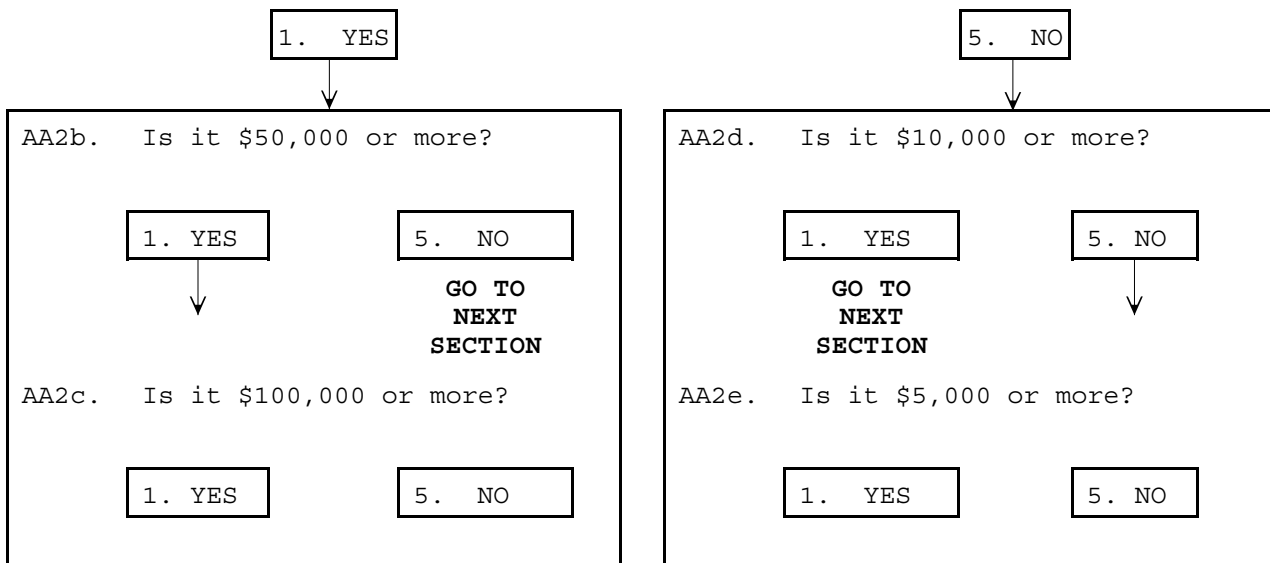

BLANK PAGE

SECTION BA: GOVERNMENT DATA

BA1. The next few questions are about the effectiveness of the mass media in communicating information from agencies of the federal government about the performance of the U.S. economy. If you do not know the exact answer but just have a rough idea, it is important for you to tell me what you know.

First, the Bureau of Labor Statistics counts people as unemployed if they are not currently working but have been actively looking for work during the prior four weeks. What was the most recent rate of unemployment published by this government agency?

_____ PERCENT

98. DON'T KNOW

GO TO BA1b

BA1a. [IF BA1 10% OR MORE] I would like to verify that I recorded your answer properly. You said the unemployment rate was [BA1] percent. Is that correct?

1. YES

GO TO BA2

5. NO

GO BACK TO BA1

BA1b. [PROBE IF BA1=DK/NA] Have you ever heard an announcement of the unemployment rate by the Bureau of Labor Statistics?

1. YES, HAVE HEARD

5. NO, HAVE NOT HEARD

BA2. Another economic indicator published by the Bureau of Labor Statistics is the Consumer Price Index, or the CPI. Compared with a year ago, what was the percentage change in overall prices as measured by the Consumer Price Index, or CPI, published by this government agency?

_____ PERCENT

98. DON'T KNOW

GO TO BA2b

BA2a. [IF BA2 10% OR MORE] I would like to verify that I recorded your answer properly. You said the percentage change in prices was [BA2] percent. Is that correct?

1. YES

GO TO BA3

5. NO

GO BACK TO BA2

BA2b. [PROBE IF BA2=DK/NA] Have you ever heard an announcement of the Consumer Price Index, or CPI, from the Bureau of Labor Statistics?

1. YES, HAVE HEARD

5. NO, HAVE NOT HEARD

BA3. The Bureau of Economic Analysis regularly publishes data on the total amount of goods and services produced in the U.S. This figure is called the Gross Domestic Product and is often abbreviated as GDP. Compared to a year ago, what was the percentage change in the Gross Domestic Product, or GDP, published by this government agency?

_____ PERCENT

98. DON'T KNOW
GO TO BA3b

BA3a. [IF BA3 10% OR MORE] I would like to verify I recorded your answer properly. You said the percentage change was [BA3] percent. Is that correct?

1. YES
GO TO BA2

5. NO
GO BACK TO BA3

BA3b. [PROBE IF BA3=DK/NA] Have you ever heard an announcement of the Gross Domestic Product, or GDP, by the Bureau of Economic Analysis?

1. YES, HAVE HEARD

5. NO, HAVE NOT HEARD

BA4. How important is it for a person like you to have exact information about the rate of unemployment, the rate of changes in prices, and the rate of change in the Gross Domestic Product -- would you say it is extremely important, very important, somewhat important, not very important, or not important at all?

1. EXTREMELY IMPORTANT

2. VERY IMPORTANT

3. SOMEWHAT IMPORTANT

4. NOT VERY IMPORTANT

5. NOT AT ALL IMPORTANT

BA5. Would you like to be more informed about these topics or would you not want any more information about these topics?

1. YES, WANT TO BE MORE INFORMED

5. NO, DON'T WANT MORE INFORMATION

BA6. We are interested in how people get official government information about the rate of unemployment, the rate of changes in prices, and the rate of change in the Gross Domestic Product. Do you get most of this type of information from television, the radio, newspapers, magazines, the Internet, your family, friends, or co-workers, your own personal experiences, some other source, or do you never get any official government information on these topics?

1. TELEVISION	2. RADIO	3. NEWSPAPERS	4. MAGAZINES	5. INTERNET
6. FAMILY, FRIENDS, CO-WORKERS	7. PERSONAL EXPERIENCE	97. OTHER (SPECIFY): _____		96. NEVER GET GOVT INFO

GO TO NEXT SECTION

BA7. What is your second most common source of official government information about these topics -- (television, the radio, newspapers, magazines, the Internet, family, friends, or co-workers, your own personal experiences, or some other source)?

1. TELEVISION	2. RADIO	3. NEWSPAPERS	4. MAGAZINES	5. INTERNET
6. FAMILY, FRIENDS, CO-WORKERS	7. PERSONAL EXPERIENCE	97. OTHER (SPECIFY): _____		96. NO MORE SOURCES (IF VOL.)

GO TO NEXT SECTION

BA8. What is your third most common source of official government information about these topics -- (television, the radio, newspapers, magazines, the Internet, family, friends, or co-workers, your own personal experiences, or some other source)?

1. TELEVISION	2. RADIO	3. NEWSPAPERS	4. MAGAZINES	5. INTERNET
6. FAMILY, FRIENDS, CO-WORKERS	7. PERSONAL EXPERIENCE	97. OTHER (SPECIFY): _____		96. NO MORE SOURCES (IF VOL.)

BLANK PAGE

SECTION D: SOCIETIES

- D1. There are many different kinds of societies and living situations around the world today. I am going to ask you to compare a variety of societies and living situations. Please tell me overall which one you think is better for most people around the world today.

Overall, which do you think is better for most people around the world today -
- a society with electricity and indoor plumbing or a society without electricity and indoor plumbing?

1. WITH ELECTRICITY/ PLUMBING	5. WITHOUT ELECTRICITY/ PLUMBING	7. OTHER (IF VOL.)	8. DON'T KNOW
GO TO D3		↓	↓

- D2. Yes, but if you had to choose, which do you think is better -- a society with electricity and indoor plumbing or a society without electricity and indoor plumbing?

1. WITH ELECTRICITY/ PLUMBING	5. WITHOUT ELECTRICITY/ PLUMBING	7. OTHER (IF VOL.)	8. DON'T KNOW
----------------------------------	-------------------------------------	-----------------------	------------------

- D3. (Overall, which do you think is better for most people around the world today --) a moderately developed society or a society that is highly developed?

1. MODERATELY DEVELOPED	5. HIGHLY DEVELOPED	7. OTHER (IF VOL.)	8. DON'T KNOW
GO TO D5		↓	↓

- D4. Yes, but if you had to choose, which do you think is better (a moderately developed society or a society that is highly developed?)

1. MODERATELY DEVELOPED	5. HIGHLY DEVELOPED	7. OTHER (IF VOL.)	8. DON'T KNOW
----------------------------	------------------------	-----------------------	------------------

D5. (Overall, which do you think is better for most people around the world today --) societies in which most women give birth in a hospital or societies in which most women give birth at home?



D6. Yes, but if you had to choose, which do you think is better (-- societies in which most women give birth in a hospital or societies in which most women give birth at home)?

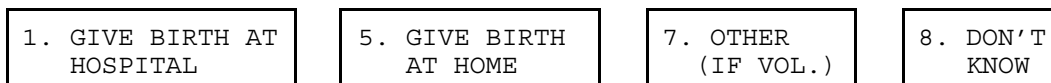

D7. (Overall, which do you think is better for most people around the world today --) culture in the United States and Western Europe or culture in other places?

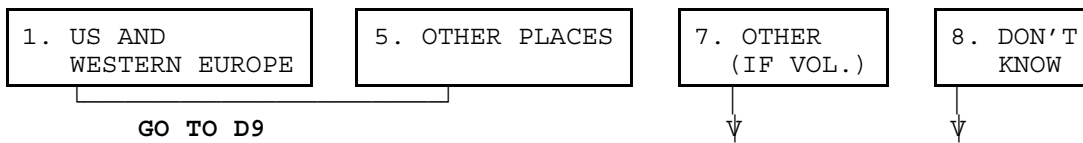

D8. Yes, but if you had to choose, which do you think is better (culture in the United States and Western Europe or culture in other places?)



D13. (Overall, which do you think is better for most people around the world today --) societies in which most families do not have television in their homes or societies in which most families do have television in their homes?

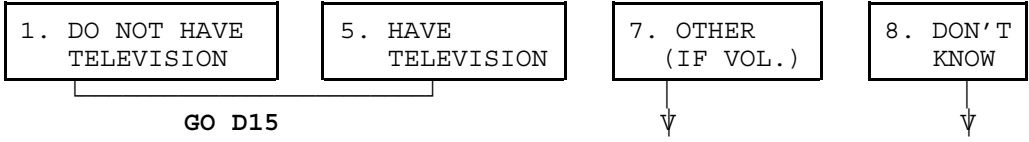

D14. Yes, but if you had to choose, which do you think is better (-- societies in which most families do not have television in their homes or societies in which most families do have television in their homes)?



- D15. Now, please think about what life is like in a country where the standard of living is low, most people live in rural areas, and access to healthcare is poor. Suppose that country introduces a program to help make the country more developed. I will read a list of things this development program might change. For each one, please tell me whether it will increase in that country or decrease in that country once the development program has been successfully implemented.

In such a country where the standard of living is low, most people live in rural areas, and access to healthcare is poor, over time, will a successful implementation of a development program increase or decrease married children living with their parents or in-laws?

1. INCREASE

3. NEITHER; ABOUT THE SAME (IF VOL)

5. DECREASE

- D16. Females marrying before the age of eighteen -- over time, will a successful implementation of a development program increase or decrease females marrying before the age of eighteen?

1. INCREASE

3. NEITHER; ABOUT THE SAME (IF VOL)

5. DECREASE

- D17. Respect for women in society (over time, will a successful implementation of a development program increase or decrease respect for women in society)?

1. INCREASE

3. NEITHER; ABOUT THE SAME (IF VOL)

5. DECREASE

- D18. Family unity and loyalty (over time, will a successful implementation of a development program increase or decrease family unity and loyalty)?

1. INCREASE

3. NEITHER; ABOUT THE SAME (IF VOL)

5. DECREASE

- D19. Marriages breaking up (over time, will a successful implementation of a development program increase or decrease marriages breaking up)?

1. INCREASE

3. NEITHER; ABOUT THE SAME (IF VOL)

5. DECREASE

D20. Arranged marriages (-- over time, will a successful implementation of a development program increase or decrease arranged marriages)?

1. INCREASE

3. NEITHER; ABOUT THE SAME (IF VOL)

5. DECREASE

D21. Babies born to unmarried mothers (-- over time, will a successful implementation of a development program increase or decrease babies born to unmarried mothers)?

1. INCREASE

3. NEITHER; ABOUT THE SAME (IF VOL)

5. DECREASE

D22. Couples having many children (-- over time, will a successful implementation of a development program increase or decrease couples having many children)?

1. INCREASE

3. NEITHER; ABOUT THE SAME (IF VOL)

5. DECREASE

D23. Opposite sex couples living together without being married (-- over time, will a successful implementation of a development program increase or decrease opposite sex couples living together without being married)?

1. INCREASE

3. NEITHER; ABOUT THE SAME (IF VOL)

5. DECREASE

D24. Respect for elders (-- over time, will a successful implementation of a development program increase or decrease respect for elders)?

1. INCREASE

3. NEITHER; ABOUT THE SAME (IF VOL)

5. DECREASE

D25. What about romantic love between a husband and wife (-- over time, will a successful implementation of a development program increase or decrease romantic love between a husband and wife)?

1. INCREASE

3. NEITHER; ABOUT THE SAME (IF VOL)

5. DECREASE

D26. Premarital sex (-- over time, will a successful implementation of a development program increase or decrease premarital sex)?

1. INCREASE

3. NEITHER; ABOUT THE SAME (IF VOL)

5. DECREASE

D27. The income difference between rich and poor people (-- over time, will a successful implementation of a development program increase or decrease the income difference between rich and poor people)?

1. INCREASE

3. NEITHER; ABOUT THE SAME (IF VOL)

5. DECREASE

D28. Elderly parents living with their adult children (-- over time, will a successful implementation of a development program increase or decrease elderly parents living with their adult children)?

1. INCREASE

3. NEITHER; ABOUT THE SAME (IF VOL)

5. DECREASE

D29. The quality of life in old age (-- over time, will a successful implementation of a development program increase or decrease the quality of life in old age)?

1. INCREASE

3. NEITHER; ABOUT THE SAME (IF VOL)

5. DECREASE

D30. Elderly people being supported by their families (-- over time, will a successful implementation of a development program increase or decrease elderly people being supported by their families)?

1. INCREASE

3. NEITHER; ABOUT THE SAME (IF VOL)

5. DECREASE

D31. Next, I would like you to think about the different kinds of social and family arrangements around the world today. I am going to ask you to compare a variety of social and family arrangements. Please tell me overall which one you think is better for most people around the world today.

First, overall, which do you think is better for most people around the world today -- married children living with their parents or in-laws or married children living separately?



D32. Yes, but if you had to choose, which do you think is better -- married children living with their parents or in-laws, or married children living separately?

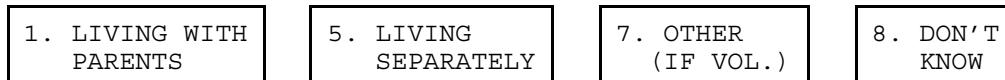

D33. (Overall, which do you think is better for most people around the world today --) a society in which there is a high degree of respect for women or a society in which there is not a high degree of respect for women?

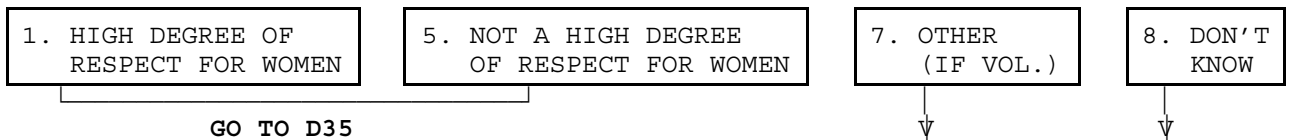

D34. Yes, but if you had to choose, which do you think is better (-- a society in which there is a high degree of respect for women or a society in which there is not a high degree of respect for women)?

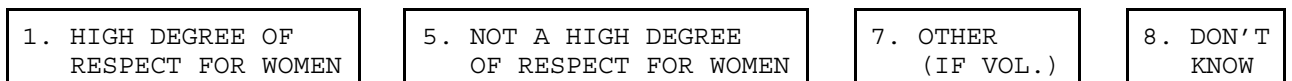

- D35. (Overall, which do you think is better for most people around the world today -- a society in which it is not acceptable for an unmarried twenty-five-year-old woman to have a baby or a society in which it is acceptable?)

1. SOCIETY IN WHICH NOT ACCEPTABLE	5. SOCIETY IN WHICH ACCEPTABLE	7. OTHER (IF VOL.)	8. DON'T KNOW
GO TO D37		↓	↓

- D36. Yes, but if you had to choose, which do you think is better (-- a society in which it is not acceptable for an unmarried twenty-five-year-old woman to have a baby or a society in which it is acceptable)?

1. SOCIETY IN WHICH NOT ACCEPTABLE	5. SOCIETY IN WHICH ACCEPTABLE	7. OTHER (IF VOL.)	8. DON'T KNOW
------------------------------------	--------------------------------	--------------------	---------------

- D37. Overall, which do you think is better for most people around the world today - having one child or having three children?

1. ONE CHILD	5. THREE CHILDREN	7. OTHER (IF VOL.)	8. DON'T KNOW
GO TO D39		↓	↓

- D38. Yes, but if you had to choose, which do you think is better (-- having one child or having three children)?

1. ONE CHILD	5. THREE CHILDREN	7. OTHER (IF VOL.)	8. DON'T KNOW
--------------	-------------------	--------------------	---------------

D39. (Overall, which do you think is better for most people around the world today --) living together before getting married or getting married without living together first?

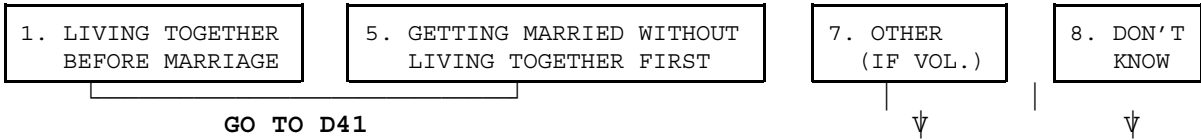

D40. Yes, but if you had to choose, which do you think is better (-- living together before getting married or getting married without living together first)?

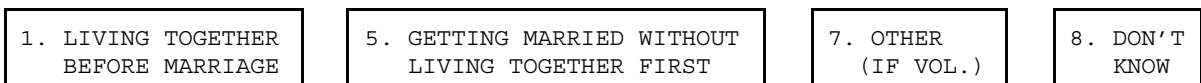

D41. (Overall, which do you think is better for most people around the world today --) elderly parents living alone or elderly parents living with their adult children?

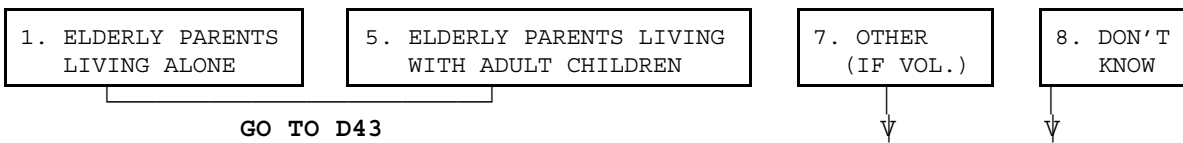

D42. Yes, but if you had to choose, which do you think is better (-- elderly parents living alone or elderly parents living with their adult children)?

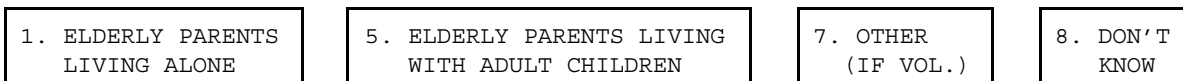

D43. Overall, which do you think is better for most females around the world today -- marrying at the age of 22 or marrying at the age of 28?

1. FEMALES MARRY AT AGE 22	5. FEMALES MARRY AT AGE 28	7. OTHER (IF VOL.)	8. DON'T KNOW
GO TO D45		↓	↓

D44. Yes, but if you had to choose, which do you think is better for most females (-- marrying at the age of 22 or marrying at the age of 28)?

1. FEMALES MARRY AT AGE 22	5. FEMALES MARRY AT AGE 28	7. OTHER (IF VOL.)	8. DON'T KNOW
-------------------------------	-------------------------------	-----------------------	------------------

D45. Overall, which do you think is better for most people around the world today - young people choosing their own spouses or parents choosing their spouses for them?

1. CHOOSE OWN SPOUSE	5. PARENTS CHOOSE SPOUSE	7. OTHER (IF VOL.)	8. DON'T KNOW
GO TO D47		↓	↓

D46. Yes, but if you had to choose, which do you think is better (-- young people choosing their own spouses or parents choosing their spouses for them)?

1. CHOOSE OWN SPOUSE	5. PARENTS CHOOSE SPOUSE	7. OTHER (IF VOL.)	8. DON'T KNOW
-------------------------	-----------------------------	-----------------------	------------------

D47. Overall, which do you think is better for a woman -- waiting until marriage to have sex or having sex before marriage?

1. WAITING UNTIL MARRIAGE	5. SEX BEFORE MARRIAGE	7. OTHER (IF VOL.)	8. DON'T KNOW
GO TO D49		↓	↓

D48. Yes, but if you had to choose, which do you think is better for a woman (-- waiting until marriage to have sex or having sex before marriage)?

1. WAITING UNTIL MARRIAGE	5. SEX BEFORE MARRIAGE	7. OTHER (IF VOL.)	8. DON'T KNOW
------------------------------	---------------------------	-----------------------	------------------

D49. Overall, which do you think is better for most people around the world today - a divorce or an unhappy marriage?

1. DIVORCE	5. UNHAPPY MARRIAGE	7. OTHER (IF VOL.)	8. DON'T KNOW
GO TO D51		↓	↓

D50. Yes, but if you had to choose, which do you think is better (-- a divorce or an unhappy marriage)?

1. DIVORCE	5. UNHAPPY MARRIAGE	7. OTHER (IF VOL.)	8. DON'T KNOW
------------	---------------------	-----------------------	------------------

D51. INTERVIEWER CHECKPOINT

 1. FORM A --> GO TO D52

 2. FORM B --> GO TO D56

D52. (Overall, which do you think is better for most people around the world today --) a society in which it is legal for a person to choose to marry someone of the same sex or a society in which it is not legal?

 1. SAME SEX MARRIAGE
LEGAL

 5. SAME SEX MARRIAGE
NOT LEGAL

 7. OTHER
(IF VOL.)

 8. DON'T
KNOW

GO TO D54



D53. Yes, but if you had to choose, which do you think is better (-- a society in which it is legal for a person to choose to marry someone of the same sex or a society in which it is not legal)?

 1. SAME SEX MARRIAGE
LEGAL

 5. SAME SEX MARRIAGE
NOT LEGAL

 7. OTHER
(IF VOL.)

 8. DON'T
KNOW

D54. (Overall, which do you think is better for most people around the world today --) a society in which it is legal for two adult women to choose to be married to the same man at the same time or a society in which it is not legal?

 1. TWO WIVES LEGAL

 5. TWO WIVES NOT LEGAL

 7. OTHER
(IF VOL.)

 8. DON'T
KNOW

GO TO D60



D55. Yes, but if you had to choose, which do you think is better (-- a society in which it is legal for two adult women to choose to be married to the same man at the same time or a society in which it is not legal)?

 1. TWO WIVES LEGAL

 5. TWO WIVES NOT LEGAL

 7. OTHER
(IF VOL.)

 8. DON'T
KNOW

GO TO D60

D56. (Overall, which do you think is better for most people around the world today --) a society in which it is legal for two adult women to choose to be married to the same man at the same time or a society in which it is not legal?

1. TWO WIVES LEGAL	5. TWO WIVES NOT LEGAL	7. OTHER (IF VOL.)	8. DON'T KNOW
GO TO D58		↓	↓

D57. Yes, but if you had to choose, which do you think is better (-- a society in which it is legal for two adult women to choose to be married to the same man at the same time or a society in which it is not legal)?

1. TWO WIVES LEGAL	5. TWO WIVES NOT LEGAL	7. OTHER (IF VOL.)	8. DON'T KNOW
--------------------	------------------------	-----------------------	------------------

D58. (Overall, which do you think is better for most people around the world today --) a society in which it is legal for a person to choose to marry someone of the same sex or a society in which it is not legal?

1. SAME SEX MARRIAGE LEGAL	5. SAME SEX MARRIAGE NOT LEGAL	7. OTHER (IF VOL.)	8. DON'T KNOW
GO TO D60		↓	↓

D59. Yes, but if you had to choose, which do you think is better (-- a society in which it is legal for a person to choose to marry someone of the same sex or a society in which it is not legal)?

1. SAME SEX MARRIAGE LEGAL	5. SAME SEX MARRIAGE NOT LEGAL	7. OTHER (IF VOL.)	8. DON'T KNOW
-------------------------------	-----------------------------------	-----------------------	------------------

D60. Now, please think about what life is like today in a country where income is low, most people live in rural areas, access to healthcare is poor, and most couples give birth to at least six children. Suppose that country introduces a smaller-family-size program to encourage couples to give birth to no more than three children. I will read a list of things this smaller-family-size program might change. For each one, please tell me whether it will increase in that country or decrease in that country once the smaller-family-size program has been successfully implemented.

In such a country where most couples give birth to at least six children, over time, will a successful implementation of a smaller-family-size program increase or decrease the overall standard of living?

1. INCREASE

3. NEITHER; ABOUT THE SAME (IF VOL.)

5. DECREASE

D61. Families having television in their homes (-- over time, will a successful implementation of a smaller-family-size program increase or decrease families having television in their homes)?

1. INCREASE

3. NEITHER; ABOUT THE SAME (IF VOL.)

5. DECREASE

D62. The fraction of children dying before their first birthday (-- over time, will a successful implementation of a smaller-family-size program increase or decrease the fraction of children dying before their first birthday)?

1. INCREASE

3. NEITHER; ABOUT THE SAME (IF VOL.)

5. DECREASE

D63. Being educated (-- over time, will a successful implementation of a smaller-family-size program increase or decrease being educated)?

1. INCREASE

3. NEITHER; ABOUT THE SAME (IF VOL.)

5. DECREASE

D64. Sick people visiting a local healer rather than visiting a medical doctor (-- over time, will a successful implementation of a smaller-family-size program increase or decrease sick people visiting a local healer rather than visiting a medical doctor)?

1. INCREASE

3. NEITHER; ABOUT THE SAME (IF VOL.)

5. DECREASE

D65. The income difference between rich and poor people (--over time, will a successful implementation of a smaller-family-size program increase or decrease the income difference between rich and poor people)?

1. INCREASE

3. NEITHER; ABOUT THE SAME (IF VOL.)

5. DECREASE

D66. Love and understanding between parents and children (-- over time, will a successful implementation of a smaller-family-size program increase or decrease love and understanding between parents and children)?

1. INCREASE

3. NEITHER; ABOUT THE SAME (IF VOL.)

5. DECREASE

D67. The fraction of people working on farms (-- over time, will a successful implementation of a smaller-family-size program increase or decrease the fraction of people working on farms)?

1. INCREASE

3. NEITHER; ABOUT THE SAME (IF VOL.)

5. DECREASE

D68. Respect for elders (--over time, will a successful implementation of a smaller-family-size program increase or decrease respect for elders)?

1. INCREASE

3. NEITHER; ABOUT THE SAME (IF VOL.)

5. DECREASE

D69. Elderly parents living with their adult children (--over time, will a successful implementation of a smaller-family-size program increase or decrease elderly parents living with their adult children)?

1. INCREASE

3. NEITHER; ABOUT THE SAME (IF VOL.)

5. DECREASE

D70. The quality of life in old age (--over time, will a successful implementation of a smaller-family-size program increase or decrease the quality of life in old age)?

1. INCREASE

3. NEITHER; ABOUT THE SAME (IF VOL.)

5. DECREASE

D71. Elderly people being supported by their families (--over time, will a successful implementation of a smaller-family-size program increase or decrease elderly people being supported by their families)?

1. INCREASE

3. NEITHER; ABOUT THE SAME (IF VOL.)

5. DECREASE

D72. Now please think about the next twenty years in the United States.

Do you think the fraction of couples living together before getting married will increase or decrease in the United States during the next twenty years?
[PROBE IF R SAYS "DK" OR "DON'T CARE": "Which do you think is more likely?"]

1. INCREASE

3. ABOUT THE SAME (IF VOL.)

5. DECREASE

D73. (If the fraction of couples living together before getting married does (increase/ decrease/stay about the same)) overall, will that be a good thing, a bad thing, or won't it matter?
[PROBE IF R SAYS "DK": "What do you think?"]

1. GOOD THING

3. WON'T MATTER; NEITHER;
STAY THE SAME; OTHER NEUTRAL

5. BAD THING

D74. Do you think the average age for a woman to first get married will increase or decrease in the United States during the next twenty years?
[PROBE IF R SAYS "DK" OR "DON'T CARE": "Which do you think is more likely?"]

1. INCREASE

3. ABOUT THE SAME (IF VOL.)

5. DECREASE

D75. (If the average age for a woman to first get married does (increase/decrease/stay about the same)) overall, will that be a good thing, a bad thing, or won't it matter?
[PROBE IF R SAYS "DK": "What do you think?"]

1. GOOD THING

3. WON'T MATTER; NEITHER;
STAY THE SAME; OTHER NEUTRAL

5. BAD THING

D76. Do you think the fraction of babies born to mothers who are not married will increase or decrease in the United States during the next twenty years?
[PROBE IF R SAYS "DK" OR "DON'T CARE": "Which do you think is more likely?"]

1. INCREASE

3. ABOUT THE SAME (IF VOL.)

5. DECREASE

D77. (If the fraction of babies born to mothers who are not married does (increase/decrease/stay about the same) overall, will that be a good thing, a bad thing, or won't it matter?
[PROBE IF R SAYS "DK": "What do you think?"]

1. GOOD THING

3. WON'T MATTER; NEITHER;
STAY THE SAME; OTHER NEUTRAL

5. BAD THING

D78. Do you think the fraction of married couples who live with their parents or in-laws will increase or decrease in the United States during the next twenty years?
[PROBE IF R SAYS "DK" OR "DON'T CARE": "Which do you think is more likely?"]

1. INCREASE

3. ABOUT THE SAME (IF VOL.)

5. DECREASE

D79. (If the fraction of married couples who live with their parents or in-laws does (increase/decrease/stay about the same) overall, will that be a good thing, a bad thing, or won't it matter?
[PROBE IF R SAYS "DK": "What do you think?"]

1. GOOD THING

3. WON'T MATTER; NEITHER;
STAY THE SAME; OTHER NEUTRAL

5. BAD THING

D80. Do you think the fraction of marriages ending in divorce will increase or decrease in the United States during the next twenty years?
[PROBE IF R SAYS "DK" OR "DON'T CARE": "Which do you think is more likely?"]

1. INCREASE

3. ABOUT THE SAME (IF VOL.)

5. DECREASE

D81. (If the fraction of marriages ending in divorce does (increase/decrease/stay the same) overall, will that be a good thing, a bad thing, or won't it matter?
[PROBE IF R SAYS "DK": "What do you think?"]

1. GOOD THING

3. WON'T MATTER; NEITHER;
STAY THE SAME; OTHER NEUTRAL

5. BAD THING

D82. Do you think that, on average, the number of children a woman gives birth to will increase or decrease in the United States during the next twenty years?
[PROBE IF R SAYS "DK" OR "DON'T CARE": "Which do you think is more likely?"]

1. INCREASE

3. ABOUT THE SAME (IF VOL.)

5. DECREASE

D83. (If, on average, the number of children a woman gives birth to does (increase/decrease/stay about the same)) overall, will that be a good thing, a bad thing, or won't it matter?

[PROBE IF R SAYS "DK": "What do you think?"]

1. GOOD THING

3. WON'T MATTER; NEITHER;
STAY THE SAME; OTHER NEUTRAL

5. BAD THING

D84. Do you think the status of women will increase or decrease in the United States during the next twenty years?

[PROBE IF R SAYS "DK" OR "DON'T CARE": "Which do you think is more likely?"]

1. INCREASE

3. ABOUT THE SAME (IF VOL.)

5. DECREASE

D85. (If the status of women does (increase/decrease/stay about the same)) overall, will that be a good thing, a bad thing, or won't it matter?

[PROBE IF R SAYS "DK": "What do you think?"]

1. GOOD THING

3. WON'T MATTER; NEITHER;
STAY THE SAME; OTHER NEUTRAL

5. BAD THING

D86. Do you think the fraction of elderly parents who live with their adult children will increase or decrease in the United States during the next twenty years?

[PROBE IF R SAYS "DK" OR "DON'T CARE": "Which do you think is more likely?"]

1. INCREASE

3. ABOUT THE SAME (IF VOL.)

5. DECREASE

D87. (If the fraction of elderly parents who live with their adult children does (increase/ decrease/stay about the same)) overall, will that be a good thing, a bad thing, or won't it matter?

[PROBE IF R SAYS "DK": "What do you think?"]

1. GOOD THING

3. WON'T MATTER; NEITHER;
STAY THE SAME; OTHER NEUTRAL

5. BAD THING

BLANK PAGE

SECTION E: DEMOGRAPHIC CHARACTERISTICS

E1_0. INTERVIEWER CHECKPOINT:

<input type="checkbox"/>	1. IF RECON AND EDUCATION NOT MISSING---> GO TO E1_1
<input type="checkbox"/>	2. IF RDD OR RECON WITH MISSING EDUCATION ---> GO TO E1

E1_1. Now I would like to confirm some information from the first interview six months ago.

In the first interview you said you had ([number] grades of schooling/[number] year(s) of college) and (did not receive a high school diploma or pass a high school equivalency test/received a high school diploma or passed a high school equivalency test/did not receive a college degree/and received a college degree). Is this correct?

1. YES GO TO E2_0	5. NO ↓
----------------------	------------

E1. (Now we would like to ask a few questions about you (and your family).)
What is the highest grade of school or year of college you completed?

GRADES OF SCHOOL	COLLEGE
<input type="checkbox"/> 0 <input type="checkbox"/> 1 <input type="checkbox"/> 2 <input type="checkbox"/> 3 <input type="checkbox"/> 4 <input type="checkbox"/> 5 <input type="checkbox"/> 6 <input type="checkbox"/> 7 <input type="checkbox"/> 8 <input type="checkbox"/> 9 <input type="checkbox"/> 10 <input type="checkbox"/> 11 <input type="checkbox"/> 12	<input type="checkbox"/> 13 <input type="checkbox"/> 14 <input type="checkbox"/> 15 <input type="checkbox"/> 16 <input type="checkbox"/> 17+

E1a. Did you get a high school graduation diploma or pass a high school equivalency test?

1. YES	5. NO
--------	-------

GO TO E2_0

E1b. Do you have a college degree?

1. YES	5. NO
--------	-------

GO TO E2_0

E1c. What is the highest degree you have earned?

1. ASSOCIATES	2. BACHELORS	3. MASTERS	4. MBA	5. LAW	6. PHD	7. MD
---------------	--------------	------------	--------	--------	--------	-------

97. OTHER: _____

E2_0. INTERVIEWER CHECKPOINT:

<input style="width: 30px; height: 20px;" type="checkbox"/>	1. IF RECON AND BIRTHDATE NOT MISSING---> GO TO E2_1
<input style="width: 30px; height: 20px;" type="checkbox"/>	2. IF RDD OR RECON WITH MISSING BIRTHDATE---> GO TO E2



E2_1. Our records show you were born in [birth month] [birth year].
Is this correct?

1. YES
GO TO E2a

5. NO



E2. What is the month and year of your birth?

_____ / _____
 MONTH YEAR

E2a. Next we have some additional questions about you. We may have talked about these things already, but we just need to confirm. Have you ever lived in an intimate relationship with a (man/woman) without being married to (him/her)?

1. YES

5. NO

E2b. Have you ever been married?

1. YES

5. NO

GO TO E3_0



E2c. Have you been married more than once?

1. YES

5. NO

E3d. Have you ever been divorced?

1. YES

5. NO

E2e. How old were you when you got married for the first time?

_____ AGE AT FIRST MARRIAGE

E3_0. INTERVIEWER CHECKPOINT:

<input type="checkbox"/>	1. IF RECON AND MARITAL STATUS NOT MISSING---> GO TO E3_1
<input type="checkbox"/>	2. IF RDD OR RECON WITH MISSING MARITAL STATUS---> GO TO E3



E3_1. Our records show that you (are married/are living with a partner/are separated/are divorced/are widowed/have never been married/are married, but your spouse is absent). Is this correct?

1. YES	5. NO
--------	-------

GO TO E3



E3_2. INTERVIEWER CHECKPOINT:

<input type="checkbox"/>	1. IF R IS MARRIED/LIVING WITH PARTNER ---> GO TO E3_3
<input type="checkbox"/>	2. IF R IS NOT MARRIED/NOT LIVING WITH PARTNER ---> GO TO E6



E3_3. Please remind me, are you married or are you living with a partner?

1. MARRIED	2. LIVING WITH PARTNER
------------	------------------------

GO TO E4 0

E3. Are you currently married, living with a partner, separated, divorced, widowed, or have you never been married?

1. MARRIED	2. LIVING WITH PARTNER	3. SEPARATED	4. DIVORCED	5. WIDOWED	6. NEVER MARRIED	7. SPOUSE ABSENT (IF VOL)
------------	------------------------	--------------	-------------	------------	------------------	---------------------------

GO TO E6



E4_0. INTERVIEWER CHECKPOINT:

<input type="checkbox"/>	1. IF RECON AND SPOUSE EDUCATION NOT MISSING---> GO TO E4_1
<input type="checkbox"/>	2. IF RDD OR RECON WITH MISSING SPOUSE EDUCATION---> GO TO E4



E4_1. In the first interview you said your (husband/wife/partner/spouse) had ([number] grades of schooling/[number] year(s) of college) and (did not receive a high school diploma or pass a high school equivalency test/received a high school diploma or passed a high school equivalency test/did not receive a college degree/and received a college degree).
Is this correct?

1. YES
GO TO E5_0

5. NO

E4. What is the highest grade of school or year of college your (husband/ wife/partner) completed?

GRADES OF SCHOOL <input type="checkbox"/> 0 <input type="checkbox"/> 1 <input type="checkbox"/> 2 <input type="checkbox"/> 3 <input type="checkbox"/> 4 <input type="checkbox"/> 5 <input type="checkbox"/> 6 <input type="checkbox"/> 7 <input type="checkbox"/> 8 <input type="checkbox"/> 9 <input type="checkbox"/> 10 <input type="checkbox"/> 11 <input type="checkbox"/> 12	COLLEGE <input type="checkbox"/> 13 <input type="checkbox"/> 14 <input type="checkbox"/> 15 <input type="checkbox"/> 16 <input type="checkbox"/> 17+
--	--



E4a. Did your (husband/wife/partner) get a high school graduation diploma or pass a high school equivalency test?	
<input type="checkbox"/> 1. YES	<input type="checkbox"/> 5. NO
GO TO E5_0	

E4b. Does your (husband/wife/partner) have a college degree?	
<input type="checkbox"/> 1. YES	<input type="checkbox"/> 5. NO
GO TO E5_0	

E4c. What is the highest degree your (husband/wife/partner) has earned?							
1. ASSOCIATES	2. BACHELORS	3. MASTERS	4. MBA	5. LAW	6. PHD	7. MD	
97. OTHER: _____							

E5_0. INTERVIEWER CHECKPOINT:

<input type="checkbox"/>	1. IF RECON WITH SPOUSE BIRTHDATE NOT MISSING---> GO TO E5_1
<input type="checkbox"/>	2. IF RDD OR RECON WITH MISSING SPOUSE BIRTHDATE ---> GO TO E5



E5_1. Our records show your (husband/wife/partner/spouse) was born in [birth month] [birth year]. Is this correct?

1. YES
GO TO E6_0

5. NO



E5. What is the month and year of (his/her) birth?

_____/_____
MONTH YEAR

E6_0. INTERVIEWER CHECKPOINT:

<input type="checkbox"/>	1. IF RECON AND NUMBER OF KIDS NOT MISSING---> GO TO E6_1
<input type="checkbox"/>	2. IF RDD OR RECON WITH NUMBER OF KIDS MISSING---> GO TO E6



E6_1. Six months ago you said there (were no children/was one child/were [number] children) 17 years old or younger in your household. Is this still correct?

1. YES
GO TO E7

5. NO



E6. How many members of your household are 17 years of age or younger?

_____ # 17 OR YOUNGER

96. NONE

E7. Counting yourself, how many members of your household are 18 or older?

_____ # 18 OR OLDER

E8_0. INTERVIEWER CHECKPOINT:

<input type="checkbox"/> 1. IF RECON AND RACE NOT MISSING---> GO TO E8_1
<input type="checkbox"/> 2. IF RDD OR RECON WITH MISSING RACE---> GO TO E8



E8_1. Our records show that your race or ethnic origin is (White or Caucasian (except Hispanic)/Black or African American (except Hispanic)/Hispanic/Native American/Asian) Is this correct?

1. YES GO TO E8a

5. NO

E8. Would you mind telling me your race or ethnic origin? Are you Hispanic or Latino?

1. YES

5. NO

E8a. (In addition to being Hispanic,) Do you consider yourself primarily white or Caucasian, black or African American, American Indian or Alaskan Native, Asian or Pacific Islander?

1. WHITE OR CAUCASIAN

2. BLACK OR AFRICAN AMERICAN

3. AMERICAN INDIAN OR ALASKAN NATIVE

4. ASIAN OR PACIFIC ISLANDER

E8b. Altogether, how many children have you (given birth to/fathered)? Include all children born alive, even if they are no longer living.

_____ TOTAL NUMBER OF CHILDREN

E8c. Next, what is the highest grade of school or year of college your father completed?

<p style="text-align: center; margin: 0;">GRADES OF SCHOOL</p> <table style="width: 100%; text-align: center; border-collapse: collapse;"> <tr> <td style="border: 1px solid black; width: 25px; height: 25px; margin: 2px;">0</td> <td style="border: 1px solid black; width: 25px; height: 25px; margin: 2px;">1</td> <td style="border: 1px solid black; width: 25px; height: 25px; margin: 2px;">2</td> <td style="border: 1px solid black; width: 25px; height: 25px; margin: 2px;">3</td> <td style="border: 1px solid black; width: 25px; height: 25px; margin: 2px;">4</td> <td style="border: 1px solid black; width: 25px; height: 25px; margin: 2px;">5</td> <td style="border: 1px solid black; width: 25px; height: 25px; margin: 2px;">6</td> <td style="border: 1px solid black; width: 25px; height: 25px; margin: 2px;">7</td> <td style="border: 1px solid black; width: 25px; height: 25px; margin: 2px;">8</td> <td style="border: 1px solid black; width: 25px; height: 25px; margin: 2px;">9</td> <td style="border: 1px solid black; width: 25px; height: 25px; margin: 2px;">10</td> <td style="border: 1px solid black; width: 25px; height: 25px; margin: 2px;">11</td> <td style="border: 1px solid black; width: 25px; height: 25px; margin: 2px;">12</td> </tr> </table>	0	1	2	3	4	5	6	7	8	9	10	11	12	<p style="text-align: center; margin: 0;">COLLEGE</p> <table style="width: 100%; text-align: center; border-collapse: collapse;"> <tr> <td style="border: 1px solid black; width: 25px; height: 25px; margin: 2px;">13</td> <td style="border: 1px solid black; width: 25px; height: 25px; margin: 2px;">14</td> <td style="border: 1px solid black; width: 25px; height: 25px; margin: 2px;">15</td> <td style="border: 1px solid black; width: 25px; height: 25px; margin: 2px;">16</td> <td style="border: 1px solid black; width: 25px; height: 25px; margin: 2px;">17+</td> </tr> </table>	13	14	15	16	17+
0	1	2	3	4	5	6	7	8	9	10	11	12							
13	14	15	16	17+															

E9. Do all of the telephones in your home have the same number, or do you have more than one telephone number in your home?

1. ALL PHONES HAVE SAME NUMBER
GO TO NEXT SECTION

5. MORE THAN ONE PHONE NUMBER
↓

E9a. Not counting cell phones, how many different telephone numbers are there in your home?
[IWER: DO NOT INCLUDE CELL PHONES.]

02. TWO PHONE NUMBERS	03. THREE PHONE NUMBERS	04. FOUR PHONE NUMBERS	_____ # PHONE NUMBERS
--------------------------	----------------------------	---------------------------	--------------------------

E9b. How many of these telephone numbers are for business use only?

96. NONE	01. ONE NUMBER	02. TWO NUMBERS	_____ # PHONE NUMBERS
----------	----------------	-----------------	--------------------------

BLANK PAGE

SECTION F: FEELINGS

F1. Now think about the past week and the feelings you have experienced. Please tell me if each of the following statements was true for you much of the time during the past week.

First, much of the time during the past week, you were happy. Would you say yes or no?

 1. YES 5. NO

F2. (Much of the time during the past week,) you felt depressed.
(Would you say yes or no?)

 1. YES 5. NO

F3. (Much of the time during the past week,) you enjoyed life.
(Would you say yes or no?)

 1. YES 5. NO

F4. (Much of the time during the past week,) you felt sad.
(Would you say yes or no?)

 1. YES 5. NO

BLANK PAGE

SECTION R: RAND

R1. Do you use e-mail or the Internet?

1. YES

5. NO

R1a. **INTERVIEWER CHECKPOINT:**

- | | |
|--------------------------|--|
| <input type="checkbox"/> | 1. RDD --> GO TO SECTION Z |
| <input type="checkbox"/> | 2. RECON AND USES INTERNET (R1=YES) --> GO TO R2 |
| <input type="checkbox"/> | 3. RECON AND DOES NOT USE INTERNET (R1=NO/DK/RF) --> GO TO R5 |

R2. We are carrying out a new study with RAND, a research organization that is working with us. The study is concerned with how American households respond to major events in their lives and public policy changes. The interviews will be conducted over the Internet rather than by telephone. We would like your permission to allow RAND to contact you for the new study. This is completely voluntary. When they contact you, you can then decide if you wish to participate or not. If you do choose to participate, RAND will pay you twenty dollars up front. After that you will receive ten dollars for every fifteen minutes of the interview that you complete.

Is it okay for us to give RAND your name, address, telephone number, and e-mail address, if you have one, along with your gender, age, education, income, race or ethnicity, and marital status so they can contact you? All your information will remain confidential.

1. YES

GO TO R7

5. NO



R3. Are you just not interested in doing the interview, or would it be difficult or inconvenient for you to complete the interview over the Internet?

1. NOT INTERESTED

GO TO SECTION Z

5. DIFFICULT OR INCONVENIENT

↓
GO TO R4

R4. To make it easier for you to participate, RAND is willing to provide you with Internet access and the necessary equipment to respond to the interview over the Internet. Is it okay for us to give RAND your name and the other information I just mentioned so they can contact you? All your information will remain confidential.

[IF R ASKS, THE INFORMATION INCLUDES: their name, address, telephone number, email address, gender, age, education, income, race or ethnicity, and marital status.]

1. YES

GO TO R7

5. NO

GO TO SECTION Z

R5. We are carrying out a new study with RAND, a research organization that is working with us. The study is concerned with how American households respond to major events in their lives and public policy changes. The interviews will be conducted over the Internet rather than by telephone. To make it possible for you to participate, RAND is willing to provide you with Internet access and the necessary equipment to respond to the interview over the Internet.

We would like your permission to allow RAND to contact you for the new study. This is completely voluntary. When they contact you, you can then decide if you wish to participate or not. If you do choose to participate, RAND will pay you twenty dollars up front. After that you will receive ten dollars for every fifteen minutes of the interview that you complete.

Is it okay for us to give RAND your name, address, telephone number, along with your gender, age, education, income, race or ethnicity, and marital status so they can contact you? All your information will remain confidential.

1. YES

GO TO R8

5. NO

GO TO SECTION Z

R7. RAND may want to contact you by e-mail. May I have your e-mail address, if you have one?

1. HAVE E-MAIL ADDRESS	5. DO NOT HAVE E-MAIL ADDRESS	9. PREFER NOT TO PROVIDE E-MAIL ADDRESS (IF VOL.)
------------------------	-------------------------------	---

↓
GO TO SECTION Z

R7a. INTERVIEWER: RECORD E-MAIL ADDRESS AND READ BACK CAREFULLY TO VERIFY SPELLING.

E-MAIL ADDRESS: _____

R8. YOU MUST VERIFY AND/OR UPDATE RESPONDENT NAME AND ADDRESS AS NECESSARY.

NAME AND ADDRESS: _____

BLANK PAGE

SECTION Z

INTERVIEWER: COPY FROM THE COVERSHEET
COMPLETE FOR BOTH RDD INTERVIEWS AND REINTERVIEWS

Z1. The sex, age, and relationship to the respondent of each of the other members of the household who are 18 years of age or older.

(a) LIST BY RELATIONSHIP TO RESPONDENT	(b) SEX	(c) AGE
RESPONDENT		

Z2. Number of calls from coversheet: _____ NUMBER

Z3. Initial refusal on coversheet:

1. YES

5. NO

Z4. Sex of the respondent:

1. MALE

2. FEMALE

Z5. Questions asked about:

1. R ONLY

2. R AND FAMILY

Z6. Interview conducted in:

1. ENGLISH

2. SPANISH

Z7. Was the respondent's understanding of the questions:

1. EXCELLENT

2. GOOD

3. FAIR

4. POOR

Z8. In general, what was the respondent's attitude toward the interview:

1. FRIENDLY &
INTERESTED

2. COOPERATIVE BUT NOT
PARTICULARLY INTERESTED

3. IMPATIENT

4. HOSTILE